

CLASS design_gianluigi landoni

680



IT_Descrizione prodotto

Divani, Poltrone, Pouf

Caratteristiche tecniche

Struttura: Massello di abete.
Molleggio: Nastri elastici intrecciati.
Imbottitura: Poliuretano espanso.
Cuscini seduta: Inserto in poliuretano espanso avvolto da materassina in piuma.
Piedi: Legno noce canaletto o metallo verniciato.
Rivestimento: Rivestimento in tessuto o in pelle.
 Rivestimento in tessuto completamente sfoderabile.

EN_Description of the product

Sofas, Armchairs, Ottoman

Technical features

Frame: Solid fir-wood.
Springing: Interlaced elastic bands.
Padding: Polyurethane foam.
Seat cushions: Core in polyurethane foam covered with a feather layer.
Feet: Canaletto walnut or varnished metal.
Cover: Fabric or leather cover. Fabric cover completely removable.

- B - Espanso densità portante / Foam supporting density
- C - Espanso densità soft / Foam soft density
- L - Fusto in legno / Wooden frame
- R - Resinato / Heated bonded polyester fibre
- P - Piuma / Feather

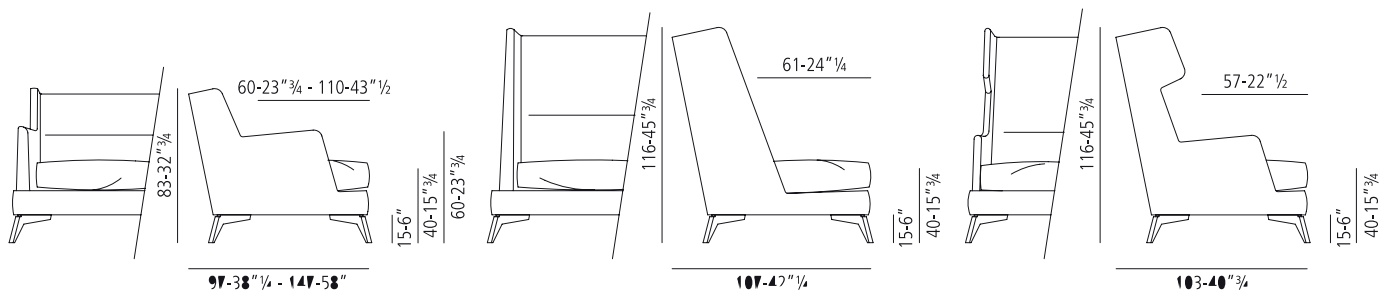
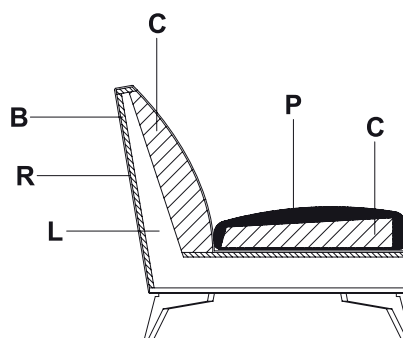

680

_pouf
_ottoman



_poltrona alta
_high armchair

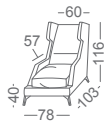

_poltrona
_armchair

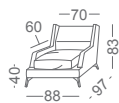

_poltrona lunga
_long armchair

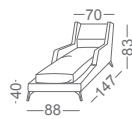

_divano alto
_high back sofa

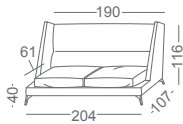

_divano basso
_low back sofa

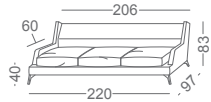

_poltroncina
_small armchair

